

SWISS ASD

Swiss Competences for Aeronautic,
Security and Defence

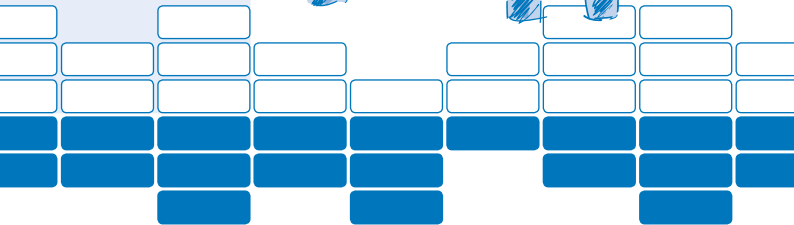
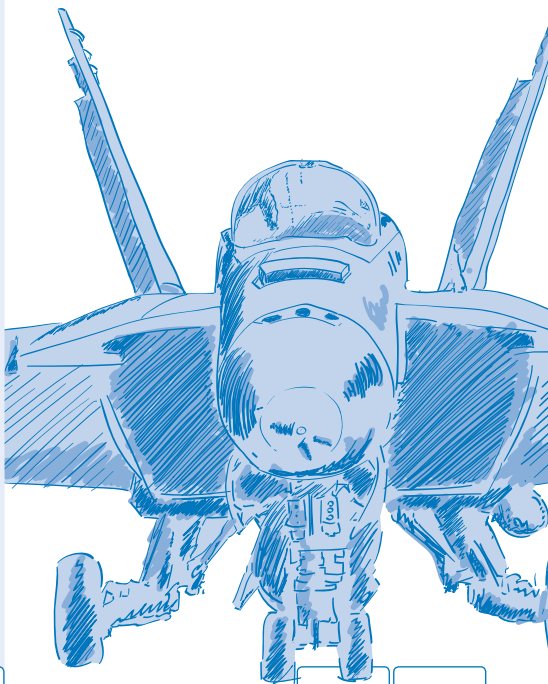

SWISSMEM

SWISS ASD
Aeronautics, Security
& Defence

Contents

| | | |
|--|------------|---------|
| ACUTRONIC Switzerland Ltd | ACU | 8 / 9 |
| Aegerter Swiss Technology AG | AEG | 10 / 11 |
| Allega GmbH | ALL | 12 / 13 |
| Alme AG | ALM | 14 / 15 |
| APCO Technologies | APC | 16 / 17 |
| Clemessy Switzerland AG | CLE | 18 / 19 |
| Crypto AG | CRY | 20 / 21 |
| CSEM | CSE | 22 / 23 |
| Curtiss-Wright Antriebstechnik GmbH | CUR | 24 / 25 |
| DESAPRO AG | DES | 26 / 27 |
| Dreyfus Aviatik GmbH | DRE | 28 / 29 |
| EDAK AG | EDA | 30 / 31 |
| Elma Electronic AG | ELM | 32 / 33 |
| FAES-PWR ESTECH AG | FAE | 34 / 35 |
| Fisba Optik AG | FIS | 36 / 37 |
| Franke Industrie AG | FRA | 38 / 39 |
| General Dynamics European Land Systems-Mowag GmbH | GEN | 40 / 41 |
| GF Machining Solutions | GFM | 42 / 43 |
| Huber + Suhner AG | HUB | 44 / 45 |
| INTERFAST AG | INT | 46 / 47 |
| JEAN GALLAY SA | JEA | 48 / 49 |
| Listemann AG | LIS | 50 / 51 |
| LORD CORPORATION | LOR | 52 / 53 |
| MagentaSys | MAG | 54 / 55 |

| | | |
|---|------------|-----------|
| Mecaplex AG | MEC | 56 / 57 |
| Meggitt Sensing Systems | MEG | 58 / 59 |
| Mercury Mission Systems International | MER | 60 / 61 |
| Meteolabor AG | MET | 62 / 63 |
| NOBAG Nobs Engineering AG | NOB | 64 / 65 |
| Oerlikon Metco AG | OER | 66 / 67 |
| Precicast SA | PRE | 68 / 69 |
| Quant Switzerland GmbH | QUA | 70 / 71 |
| Rheinmetall Air Defence AG | RAD | 72 / 73 |
| Rheinmetall Swiss SIMTEC AG | RAS | 74 / 75 |
| Rheinmetall Technical Publications Schweiz AG | RTP | 76 / 77 |
| Roschi Rohde & Schwarz AG | ROS | 78 / 79 |
| RUAG Holding AG | RUA | 80 / 81 |
| SAAB Bofors Dynamics Switzerland Ltd. | SAA | 82 / 83 |
| Saint Jean Aero | SJA | 84 / 85 |
| Sauter, Bachmann AG | SAB | 86 / 87 |
| Starrag AG | STA | 88 / 89 |
| OTTO SUHNER AG | SUH | 90 / 91 |
| SSZ Camouflage Technology AG | SSZ | 92 / 93 |
| SAN SWISS ARMS AG | SWI | 94 / 95 |
| Systems Assembling SA | SYS | 96 / 97 |
| Thales Suisse SA | THA | 98 / 99 |
| Safran Vectronix AG | SAF | 100 / 101 |
| ViaSat Lausanne | VIA | 102 / 103 |
| Webasto Thermo & Comfort Schweiz AG | WEB | 104 / 105 |

Introduction

It is impossible to think of our globalized world without international air traffic. Airplanes provide the safest means of transport. In order to ensure that this continues well into the future, the aerospace industry provides seamless traceability along the whole production chain and demands high standards of reliability and precision from suppliers.

As the Head of the Federal Department of Economic Affairs, Education and Research, I make the connection between research, innovation and the production of airplanes. Modern airplanes are produced with new, lighter materials. Today's engine technology makes it possible to continuously and massively reduce fuel consumption, pollutant emissions and noise exposure.

As the home of leading international universities for technology and the natural sciences in Zurich and in Lausanne as well as of regionally organized universities of applied sciences, Switzerland is an excellent location for research and development. This environment provides the ideal conditions for our industry to offer itself worldwide as an innovative and future-oriented partner.



Johann N. Schneider-Ammann
Federal Councillor

Introduction

The world in which we live today is globalized and highly networked. This situation holds both opportunities and risks for armasuisse, the central procurement organization for armaments.

One of the effects of declining defence budgets over the past decades has been the global consolidation of the armaments industry. As a result, the competitive pressure on Swiss industry has increased considerably. A small domestic market in terms of volume, stringent export regulations and growing competition in the armaments sector present challenges for Switzerland's industrial base. It is highly likely that security-related industrial skills will be lost, due not least to the outsourcing of production abroad and to services and products being geared to the global market.

We therefore need to help preserve and strengthen key competencies and technologies through appropriate measures, and through the procurement process in particular. It is vital for armasuisse to cooperate with those elements of Switzerland's technological and industrial base that are relevant to security. They are key partners for us.



Martin Sonderegger
National Armaments Director

Facts & Figures

Swissmem represents the interests of over 1000 companies in Switzerland's mechanical and electrical engineering industries (MEM industries, total of 320000 employees) and related technology-oriented sectors. Drawing on its broad-based knowledge of the sector, Swissmem advocates the best possible economic and political framework for industry towards politicians, government, employer organizations and the public.

Swissmem also supports its members by providing services that are tailored to the needs of companies in the MEM industries. These include free professional advice on employment, commercial, contract and environmental law, energy efficiency and knowledge and technology transfer. Swissmem's goal is to ensure that companies in the MEM industries remain competitive internationally and are able to continue creating and safeguarding jobs in Switzerland.

In the Aerospace field, our member companies produce instruments and special components for the aeronautical industry, act as partners for cell construction and engine technology, have highly specialised manufacturing knowhow and are certified in accordance with the relevant regulations.

In the Security and Defence Technology field, our member companies offer high-precision manufacturing technologies such as components and assemblies. The main products are safety-relevant equipment, radar systems, ammunition systems, complex weapon, command & control & information systems, optronics, crypto technology, protective clothing and maintenance and training support services.

Introduction

As the SWISS ASD President, it makes me very proud to introduce you to the rich diversity of our industry.

The 50 member companies of SWISS ASD have a long-standing reputation for delivering on time, and for being reliable, forward-thinking partners. We provide jobs for about 10,000 employees including engineers, scientists and qualified professionals as well as apprentices. Moreover, the Swiss economy benefits from our outstanding trainee programmes. They help to secure the development of the next professional generation.

SWISS ASD companies produce components and tools for the aerospace industry and are partners in many major international aerostructure and engine projects. We offer highly specialized manufacturing know-how and are certified according to international standards.

In the security and defence sector, our companies act as general contractors as well as suppliers. We provide complete systems and specialised high-tech components in the field of safety relevant-equipment, weapon and ammunition systems, armoured vehicles, the entire C4I STAR domain, including MRO, training and simulation.

Let us be your strong, reliable and innovative partner!



A handwritten signature in blue ink that reads "B. Giger".

Bruno E. Giger
President SWISS ASD

ACUTRONIC

The Driving Force in Motion Simulation™

ACUTRONIC is the world leader in the development, design, and manufacture of precision motion simulation solutions for the aviation, space, defense, transportation, and consumer electronics industries.

ACUTRONIC employs over 120 people from offices in Switzerland, the USA, and Spain. Products include one, two, and three-axis simulators; Hardware-In-The-Loop five-axis simulators; flight motion simulators; and target motion systems. ACUTRONIC's products make it possible for customers to accurately reproduce motion profiles in laboratory or production environments. Common applications include testing and calibrating gyroscopes, accelerometers, MEMS-based sensors, inertial measurement units, avionics equipment, star trackers, and other similar instruments. To ensure high fidelity with real environments, temperature chambers and other features are often required. These products help customers to accelerate R&D development or production-line efficiency.

ACUTRONIC brings to bear market-leading teams in mechanical, electrical, software, and systems engineering. The firm has a deep bench of project management expertise and dedicated customer service technicians.



ACUTRONIC Switzerland Ltd

Rosengartenstrasse 25

CH-8608 Bubikon

+41 55 253 55 55

office@acutronic.ch

www.acutronic.ch



AEGERTER Swiss Technology AG is a Swiss SME owner-run company that has positioned itself in almost 40 years as a specialist for complex parts and special materials on the international market. The company is certified according to EN 9100:2009 SQS corresponds to AS 9100. In addition to engineering, automotive, pharmaceutical / chemical and defense aviation is another strong growing field of activity. The modern machinery with the appropriate infrastructure, such as robotics, CAD / CAM system, 3D measuring department and ultrasonic washing system is the foundation for success the firm with over 20 professionals. In the current processing and turning centre can be processed up to cubic 1200x1200/1600. Our machining centers are all 5-axis, some with robots or pallet changer. The turning center have some robots, bar feeder systems, up to 3 turrets, 3 Y-axis and up to 12 axes. One of our strength is the support from prototype / single pieces to series. Are through constant investment and strong partnerships with suppliers we are always on the cutting edge of technology and work everyday with materials such as titanium, super alloys (HRSA), Inconel nickel UDN.



Aegertter Swiss Technology AG

Bühlackerstrasse 7

CH-3627 Heimberg

+41 33 439 23 00

info@aegertterag.ch

www.aegertterag.ch



ALLEGA

ALLEGA is a specialised service provider in distribution of standard and pre-machined semi-finished aluminium products for the aeronautical and space industries but also for machine, transport and façade industries.

With a comprehensive inventory, cutting and pre-machining capacity (CNC milling and drilling machines), combined with extensive logistic, technical and international supply chain expertise as well as available e-commerce solutions, we provide a full service package according to individual customer needs.

We create value and benefits for our customers by being a reliable, flexible and efficient partner along the entire value chain between supplier and customer.

ALLEGA is certified according to ISO 9001, EN 9120, ISO 14001 and OHSAS 18001.

ALLEGA, your leading partner for aluminium.

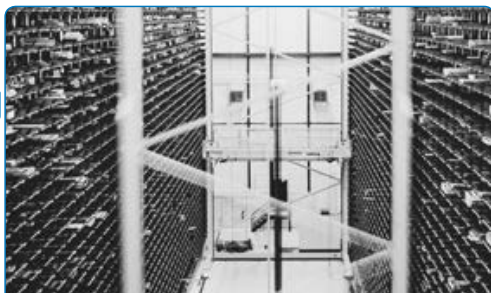

Allega GmbH

Seeblerstrasse

CH-8172 Niederglatt

Tel. +41 44 852 41 18

Fax +41 44 852 43 44

info@allega.ch

www.allega.ch



ALME is a leading manufacturing company specialized in the production and assembly of high-precision machinery and components. We build, assemble, adjust, align and measure – with almost zero tolerance – for both prototypes and small series. In addition, clients benefit from our expertise in high tech manufacturing consulting services.

We develop cutting-edge solutions for various sectors, with a focus on digital printing, medtech, aerospace, defence and semiconductors. Customers such as ETH Zurich and the Paul Scherrer Institute which build's the SwissFel (an x-ray free-electron laser) are only two of the many clients who trust in the ALME capabilities. ALME is a preferred HP partner over 20 years in the printing business with ISO 9000ff and ISO 14000 certificates. Our portfolio covers drums for digital printing presses as well as feeding and paper processing systems and printing heads. We also produce high-precision milling parts for EUV-technology and components for high-vacuum solutions.

Our services ensure that all client needs are met: from production and packaging engineering to material definition, planning and processing; from purchasing and global sourcing to first article inspection reports (FAIR) and statistical process control (SPC).

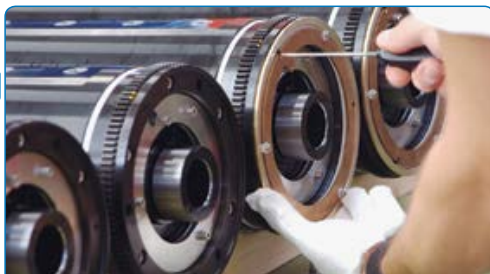

ALME

Industriestrasse 11
CH-8355 Aadorf
+41 52 368 02 68
info@alme.ch
www.alme.ch



APCO

TECHNOLOGIES

APCO Technologies is a privately owned company founded in 1992 and located in Aigle.

We employ 350 qualified people and we are specialised in the design and manufacture of high quality mechanical and electromechanical equipment for the Space, Defense and Energy domains.

APCO Technologies provides innovative and competitive solutions to customer's specific requirements and master project management, design, development, production, testing, installation, operation and on-site support activities.

We deliver Aerospace Equipment including Launcher and Spacecraft Structures, Instrument Structures, Instruments, Mechanisms, Mechanical Ground Support Equipment. At the Guiana Space Center, APCO Technologies is in charge of the operations and the maintenance of the Payload Preparation Facilities, the Individual Protection Equipment and is responsible for the mechanical group.

We also have gained throughout the years a strong and recognised experience in the design, the manufacturing and the tests of highly secured handling and lifting means for defense, shipbuilding and energy applications and we are EN 9100, ISO 9001, ISO 14001, ISO 27001 and OSHAS 18001 certified.

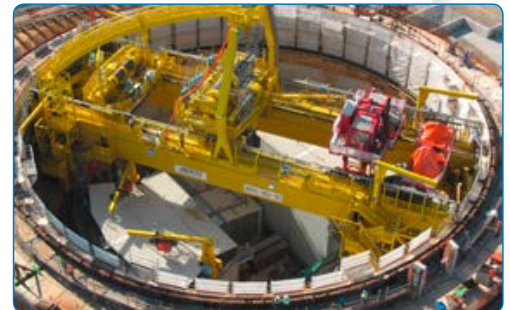

APCO Technologies

Chemin de Champex 10

CH-1860 Aigle

+ 41 24 468 98 00

info@apco-technologies.eu

www.apco-technologies.eu





The most demanding industries have trusted Clemessy Switzerland with their projects, making our company a key player on the aerospace, scientific research and transportation infrastructures markets.

From design & production, up to integration & support, we provide Assembly, Integration & Test/Validation (AIT/AIV) systems for major aerospace programs. Besides this EGSE/STTE offering, our knowledge on hardware & software in the loop (HIL/SIL) allows us to supply tailor-made integration rigs (ironbird, flatsat) with the appropriate harnesses. As a matter of fact, Clemessy has been involved in the past decades in 80% of every satellites programs headed by the European Space Agency.

Moreover, we provide monitoring and control systems as well as maintenance engineering to guarantee your critical processes performances in test centers, wind tunnels, cleanrooms, vacuum chambers, airports lighting...

With our 5'000 employees parent group you benefit from a stable partner with a century of experience in electrical engineering. Thanks to Clemessy Group's international locations and network of partners, we support our valued customer all over the world.

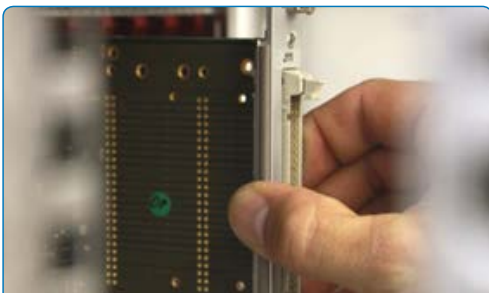

Clemessy Switzerland AG

Güterstrasse 86B

CH-4053 Basel

+41 61 205 31 50

cys.ch@clemessy.com

www.clemessy.ch



CRYPTO

Crypto AG was founded in 1952 and currently employs about 250 people. Today, the company is an international leader in Information Security for government authorities. All Encryption Solutions from Crypto AG are developed exclusively in-house and manufactured in the company's own production facility at corporate headquarters in Steinhausen, Switzerland.

The solutions from Crypto AG protect information in modern office settings, in radio and satellite communication and in every type of network. These capabilities indicate the great powers of innovation the company possesses. The comprehensive Security Architecture for the Information Security Solutions ensures the confidentiality, integrity, availability and authenticity of data warranting protection.

The clientèle of Crypto AG includes governmental organisations engaged in State Governance, Diplomacy, Internal Security and Defence as well as International Organisations and relies on highly complex and secure IT and communication infrastructures. To meet these highest security requirements, the customer-specific Information Security Solutions from Crypto AG are based on a unique Security Architecture.

INTEGRATED EXPERTISE.
FOR EXCLUSIVE SECURITY.



Crypto AG
P.O. Box 460
CH-6301 Zug
Tel. +41 41 749 77 22
Fax +41 41 741 22 72
crypto@crypto.ch
www.crypto.ch



CSEM PROFILE CSEM is a private, not-for-profit Swiss research and technology organisation. It delivers advanced technologies and unique R&D services to the industrial sector. Supported by federal and cantonal authorities CSEM bridges the gap between academic findings and industrial requirements.

Specifically, CSEM develops, integrates, and matures innovative technologies through five strategic programs: Microsystems, Systems, Ultra-low power integrated systems, Surface engineering and Photovoltaic and transfers them to established industrial partners. Its support to industry ranges from feasibility studies through custom product-development based on advanced technologies, to small-series production.

CSEM multi-disciplinary programmes are applied to aeronautics and aviation in many different ways such as integrated, autonomous wireless sensor networks powered with energy-harvesting devices to perform health monitoring on aircraft structures, development of high-performance MEMS and miniaturized sensors, measurement of pressure distribution and airflow on aircraft wings with a pressure sensor strip and pressure sensing paint technologies, non-destructive inspection and testing of primary aeronautics structures using phase contrast X-ray imaging.

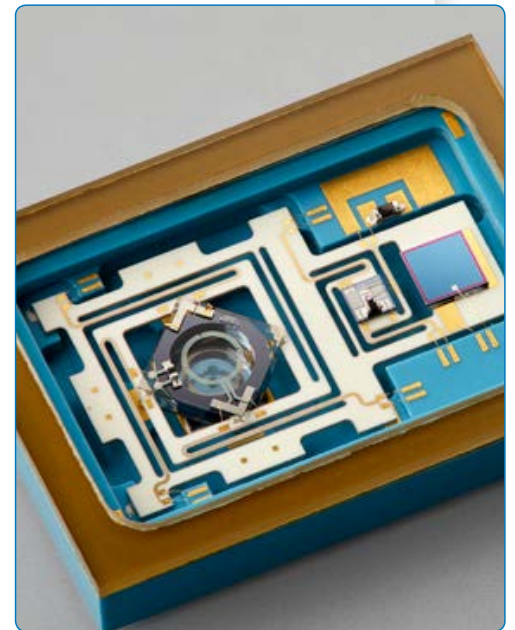
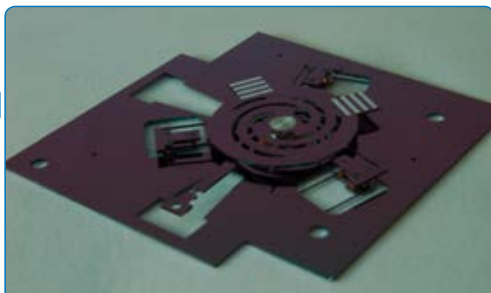

CSEM

Rue Jaquet-Droz 1
CH-2002 Neuchâtel
+41 32 720 51 11
info@csem.ch
www.csem.ch



CURTISS - WRIGHT

Curtiss-Wright Drive Technology, part of the Curtiss-Wright Defense Solutions Division, has been a global leader in the development and manufacturing of electromechanical systems used in the industrial and defense industries for over 70 years. It provides both industries with comprehensive solutions for all customer requirements, as well as cost-effective options through the use of standard products. As a Swiss company, quality, reliability, and environmental protection are the foundation of our business. Our core competency is the development of customized drive solutions through customer partnerships.

Our products:

Aiming and Stabilization Drive Systems: Rotary Gear Drives, Linear Gear Drives, Motor Controllers, Hand Controllers, Gyroscopes

Ammunition Handling Systems: Flick Rammer, Ammunition Handling & Feeding Systems

Industry: Train Tilting Technology, Camera Crane Stabilization, High Viscosity Screw Pumps

Extensive Services: Program management, Drive integration and commissioning, Spare parts service, Maintenance, Repair and Overhaul (MRO), Staff training, Technical consulting, Integrated Logistic Support (ILS)



Curtiss-Wright

Antriebstechnik GmbH

Badstrasse 5

CH-8212 Neuhausen am Rheinfall

+41 52 674 65 22

drivetech-support@curtisswright.com

www.curtisswrightds.com/drivetech



DESAPRO

Founded 1959 as EDAK, the company today is an international leader in the manufacturing of aluminum rack mounts, transit & equipment cases for the aerospace, defense, medical and energy industries.

The aluminum cases are engineered to endure the severe conditions of field operations, military and commercial transport of sensitive goods. DESAPRO cases are built to withstand and to protect their content against shock, vibration, water, dust, corrosion and EMI.

The products consisting of:

MILEX 19 inch housings: These are designed with unique expertise to meet rigid requirements of the military and developed to customer specific needs



STANEX transport cases: The unique design results in special ruggedized features which guarantees the safety and protection of goods

PORTEX instrument cases: Light weight design for most demanding protection of sensitive equipment



KOOLEX temperature control: We offer cooling and heating solutions for any level of complexity

All our customized aluminum solutions are offered based on the specific needs and specifications of our Customers and their industry.

DESAPRO is an international company with the Headquarters in Switzerland and a Sales and manufacturing facility in the United States.

DESAPRO AG
Rheinauerweg 17
CH-8447 Dachsen
www.desapro.com



DREYFUS AVIATIK

Beratung und Support

- 50 Jahre Erfahrung im Luft- und Raumfahrt Business
- Fachexperte Aerospace
- Hervorragendes regionales, überregionales und internationales Beziehungsnetz in der Aerospace Industrie
- Dienstleistungsschwerpunkte Aviatik Engineering Services Aviatik Engineering Consulting Aviatik Integrated Logistic Support Aviatik Training



Dreyfus Aviatik GmbH

Zentralstrasse 42

CH-6030 Ebikon

+41 41 440 57 57

EDAK

Expertise in the processing of materials EDAK produces and sells products made of aluminium and stainless steel, with high standards of quality and technology. The ongoing training and advancement of our staff, the continuous modernization of the machinery and the high investment in engineering are the factors behind the first-rate market position of EDAK, ensuring our exceptional expertise as a partner. EDAK products are of great benefit to customers in solving specific problems, and they are processed to high standards, using only durable components and materials.

MILEX 19"-Housing EDAK's unique expertise in the development of custom-made solutions means MILEX transit cases are manufactured exactly to customer specifications and always delivered on time.

KOOLEX – Temperature Control Our KOOLEX product line starts at the low end of complexity with fans and on the high end with active vapour cycle air conditioning. Depending on the heating or cooling requirements, availability and type of electrical power we will find the best system for any application.

STANEX Cases We manufacture top quality cases using corrosion-resistant materials in a handsome design.



EDAK AG

Rheinauerweg 17
CH-8447 Dachsen
+41 52 647 21 11
edak@edak.ch
www.edak.com

EDAK Inc.

630 Distribution Drive
Melbourne, Florida, 32904
USA
+321 674 68 04
www.edak.com



ELMA

Your Solution Partner

Elma Electronic AG is a global manufacturer of products for housing electronic systems and rotary switches. Founded in 1960, the company provides everything from components, such as rotary switches, modular enclosures, cabinets and backplanes to complete standard or custom system platforms. Our core competency is the design and manufacturing of turnkey solutions on purpose-built site. We are AS9100 approved and involved in numerous major defense programmes.

Field Deployable Chassis Platforms and Rugged Switches designed for use in the harshest environments and MIL-rugged applications.

When facing shock, vibration, strick EMC, airborne, shipboard, Zone 4 earthquake, salt fog, or other condition, we offer a comprehensive line of 19" Rackmount, ATR and Small Form Factor (SFF) and Rotary Switch solutions to meet these demands. Our products have a proven and tested history of operating in critical situations when subjected to MIL-STD, Seismic, Telcordia, NEMA or other harsh environmental standards.

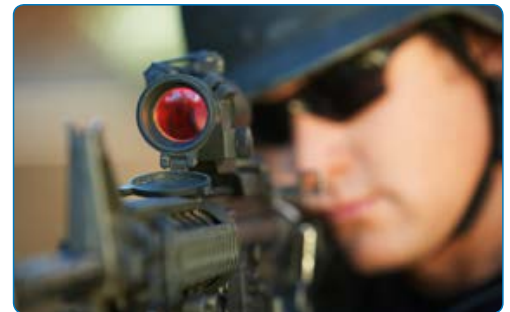

Elma Electronic AG

Hofstrasse 93
CH-8620 Wetzikon
+41 44 933 41 11
sales@elma.ch
www.elma.com





FAES-PWR ESTECH AG is a reliable, value-adding partner for the **production of high-tech precision parts**. Our industrial customers are major national and international companies, which seek to optimize their value chain and substantially increase their profitability. FAES-PWR ESTECH AG manufactures **precision parts for quality-conscious customers, for single parts, special execution products, prototypes as well as repetition parts**. With the latest generation of CAD & CAM – systems, model-based design, professional production planning and highly automated state-of-the-art CNC machines, qualified experts ensure precise and efficient production for **batch sizes 1 to 1'000**.

We support our outsourcing customers along the value chain with **technical expertise and cost advantage**. Our process competences and a unique and fully integrated production system support our business. While we are certainly a well-established Swiss company, belonging to ESTECH Industries Holding AG, we are also highly internationally oriented and committed to a dynamic development. The company is certified to EN 9100.



FAES-PWR ESTECH AG

Neuhofstrasse 10
CH-8630 Rüti
Tel. +41 55 251 44 00
Fax +41 55 251 44 09
faes-pwr@estech.ch
www.estech.ch



FISBA Innovators in Photonics

FISBA is a worldwide leading manufacturer of optical systems, microsystems and customized components for security, defense and aerospace. Our highly qualified lens designers and engineers are always on the lookout for the perfectly tailored solutions of specific customer needs. Our core competencies are the design, development and manufacturing of:

Optical Systems and Subassemblies: Lens systems; Vision systems and cameras; Head up displays; Fire control systems; Laser modules. **Optical Microsystems:** Objectives; Pico projectors; Micro cameras. **Advanced Optical Components:** Precision molded lenses; Fast axis collimation lenses (FACs); Slow axis collimation lenses (SACs); FISBA Beam Twister™; Aspheres; Lens arrays.

New technologies for advanced glass, plastic and IR optics
FISBA employs precision molding of free forms and aspheric components, opening up totally new possibilities in the customer's system development and assembly optimization. Geometric forms made of glass, which were considered "impossible" so far, can be realized. FISBA offers you support and intelligent solutions for advanced optics such as design, production, coating, assembly and qualifying.



FISBA AG

Rorschacherstrasse 268
CH-9016 St. Gallen
+41 71 282 31 31
info@fisba.com
www.fisba.com



FRANKE

Franke Industrie AG

When it comes to fabricated components Franke Industrie AG is your reliable partner within the Gas Turbine, Aerospace and Space industry. With more than 60 years of experience we inventively support your projects from the very first concept to the engine-ready component.

Facts & Figures

Franke Industrie AG is based in Aarburg Switzerland and employs currently around 80 employees. We are part of the globally active Swiss Artemis Group.

Products

Our focus in the aerospace market lies on fast prototyping as well as serialization of special components. Our "One Stop Shop Strategy" enables us to produce engine ready components for its customers.

Quality management

The Management System at Franke Industrie AG is based on the EFQM Model and includes the following Certificates: EN ISO 9001:2008, EN ISO 14001:2004, EN ISO 3834-2:2005, OHSAS 18001:2007 (EKAS), DIN EN 9100:2009, Nadcap NonDestructive Testing

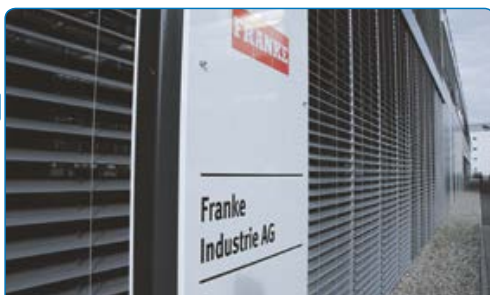

Franke Industrie AG

Franke-Strasse 2
CH-4663 Aarburg
+41 62 787 31 31
industrie-info.ch@franke.com
www.industech.ch



GENERAL DYNAMICS

European Land Systems–Mowag

General Dynamics European Land Systems-Mowag develops, designs and produces technologically superior highly protected vehicles for military, police and security forces use. More than 16'000 wheeled vehicles of the types EAGLE, DURO and PIRANHA are in operation worldwide with a large number of nations. With its products GDELS-Mowag offers modular and flexible solutions for the full spectrum of operations in the weight classes 5 – 40 tons.

The EAGLE and DURO families of light tactical vehicles are based on an innovative vehicle concept for a wide range of missions. Available in 4x4 and 6x6 configurations, variants such as Patrol, Reconnaissance, Police, Troop Transport, Logistic Transport, Ambulance, Recovery, etc. are available. Their reliable technology is field proven and offers unrivalled and secure mobility on- and off road by means of its De-Dion axle system with patented roll stabilizer.

The world famous PIRANHA 8x8 family of vehicles provides the basis for numerous mission roles as expected of a modern multirole vehicle. A wide range of variants has been built to meet customer specific requirements. The vehicle has demonstrated high protection, mobility and reliability with low operating cost in countless missions around the globe.



**General Dynamics European
Land Systems-Mowag GmbH**

Unterseestrasse 65
CH-8280 Kreuzlingen

+ 41 71 677 55 00

www.gdels.com

+GF+

Divisions of the Georg Fischer group:

GF Machining Solutions is a leader in high-speed and high performance Milling, Electrical Discharge Machining (EDM), Laser texturing, Micromachining, Additive Manufacturing, Spindles, Automation, Tooling and software, and Customer Services solutions.

With 60-plus years of expertise in key aerospace technologies, from manufacturing structural parts, to engine components and avionics, turbine blade repair and traceability solutions, GF Machining Solutions keeps its aerospace customers flying high above the competition.

GF Automotive makes modern mobility lighter with innovative lightweight solutions for cast components in iron, aluminum and magnesium.

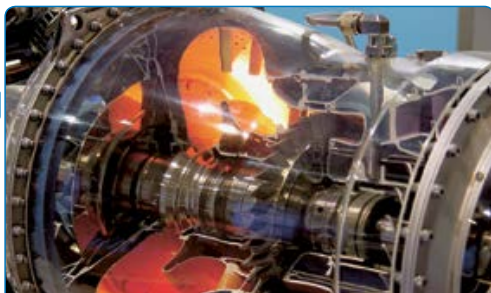

GF Machining Solutions

Business Development-Segmentation

Rue du Pré-de-la-Fontaine 8

CH-1217 Meyrin, Geneva

+41 22 783 31 11

dedicated.solutions@georgfischer.com

www.gfms.com



Your partner for system solutions

HUBER+SUHNER is a leading international manufacturer and supplier of components and systems for electrical and optical connectivity. HUBER+SUHNER unites technical and manufacturing expertise in radio frequency, fiber optics and low frequency technologies under one roof and offers a high-quality product range for the defense market. HUBER+SUHNER develops and manufactures cables and connectors for applications worldwide. Connectors and cables can be optimized for superior electrical performance. We currently offer over 1700 different connector configurations. These products have been tested to IEC, MIL, CECC and other standards.

HUBER+SUHNER's extensive range of antennas provides an ideal platform for delivering best-in-class communication and jamming systems. Flexible configuration options that include systems-level testing provide the finishing touches to this fast-growing offering.

HUBER+SUHNER's defense portfolio covers all of the products required for an end-to-end connectivity solution. These include connectors, EMPs, antennas, cable assemblies as well as a host of interface panes, racks and junction boxes.

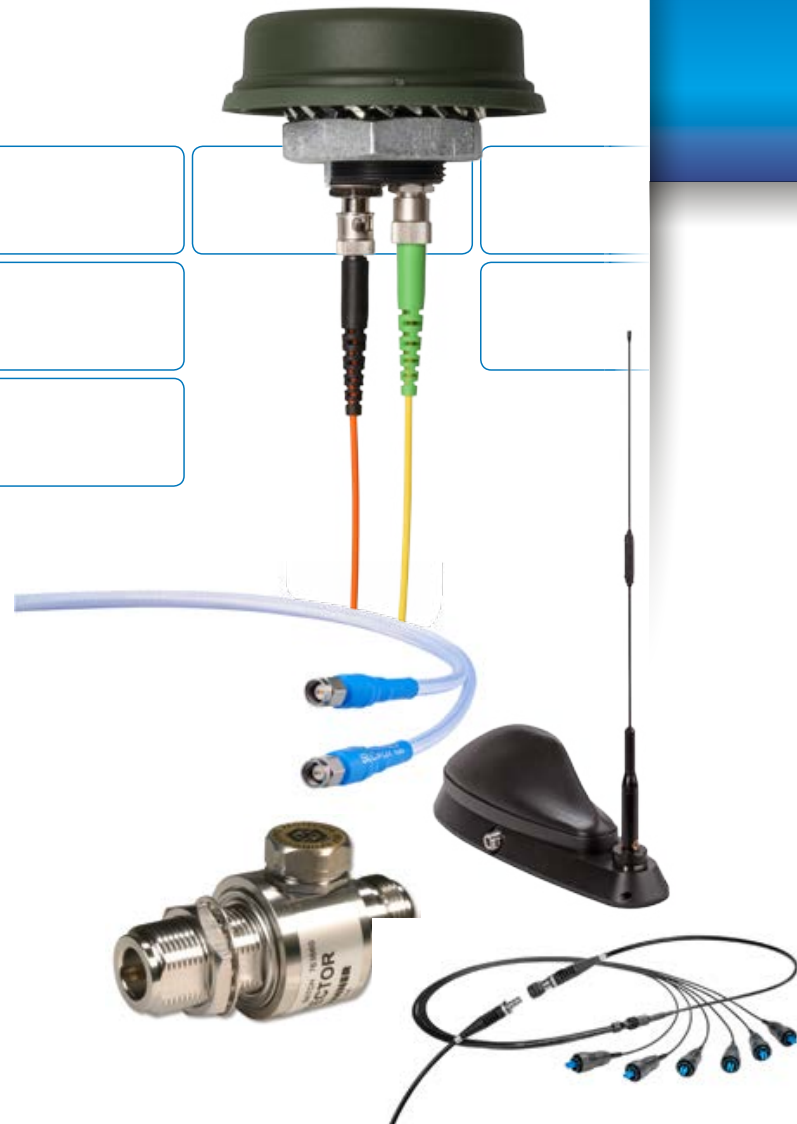

Huber + Suhrner AG

Tumbelenstrasse 20
CH-8330 Pfäffikon ZH

+41 44 952 22 11

info@hubersuhner.com

www.hubersuhner.com



INTERFAST is agent and sales representative of major US and European manufacturers of aerospace fasteners. Agency agreements with stockists allow fast delivery of standard parts.

INTERFAST AG vertritt in der Schweiz als Exklusivagent die wichtigsten europäischen und amerikanischen Hersteller bzw. Verteiler von Schrauben, Muttern und Normteilen für die Luftfahrt gemäss Kundenzeichnungen oder geltenden Normen.

INTERFAST SA est agent exclusif pour la Suisse des principaux fabricants ou distributeurs US et européens de visserie aéronautique répondant aux normes constructeurs ou aux standards nationaux.



INTERFAST AG

Steinhauserstrasse 70
CH-6301 Zug
+41 41 749 64 16
info@interfast.ch
www.interfast.ch



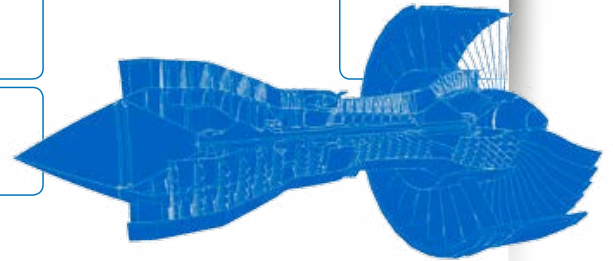
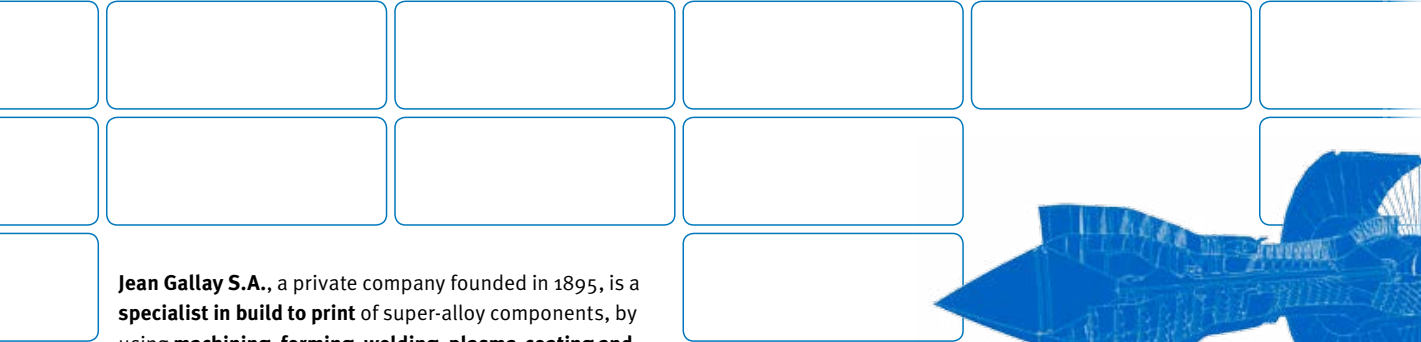

Jean Gallay S.A., a private company founded in 1895, is a **specialist in build to print** of super-alloy components, by using **machining, forming, welding, plasma-coating and heat-treatment** for **Aerospace** and **Energy**. In these fields, the name Jean Gallay is synonymous with outstanding technical expertise, stringent quality control and non-destructive testing at all stages of manufacturing.

Jean Gallay S.A. has many certifications for its quality systems, including **ISO 9001, ISO 14001** and **AS/EN9100** for manufacturing as well as **EASA Part 145** for repairing, in addition to certifications required by its customers. The company was among the first in Europe to receive the coveted **NADCAP** accreditation for special processes in aerospace.

Uncompromising standards are maintained at all times to ensure that Jean Gallay products and services achieve the **highest levels of precision, quality and reliability**.



JEAN GALLAY SA
108, chemin du
Pont-du-Centenaire
CH-1228 Plan-les-Ouates
+41 22 794 77 66
sales@jean-gallay.ch
www.jean-gallay.com



Listemann AG is a leading, cost efficient service provider of special processes. We support our clients in using new materials for the development and construction of complex high-end components and engines by applying the following ISO and Nadcap certified technologies:

Heat treatment in high-vacuum and inert gas atmosphere (including nitriding): We precisely modify the characteristics of materials according to customer specifications in order to improve the machinability as well as the shelf-life of the final application.

Brazing: High temperature brazing in vacuum or inert gas atmosphere is a core competence of Listemann AG for connecting a wide range of different materials with joints of exceptional strength.

Electron beam welding: With a part allowance up to 1.2 x 1.6 m, our state-of-the-art equipment is able to deliver a superior quality of weld beads while joining all types of precision components in a wide variety of materials.

Engineering: Listemann AG is headed by internationally renowned materials engineering experts. With our network to leading research organisations and material and equipment manufacturers, we assure an immediate know-how transfer into our customers innovation and production processes.



Bild: SR Technics

Listemann AG

Sulzer Allee 25, Postfach
CH-8404 Winterthur

+41 52 262 56 22

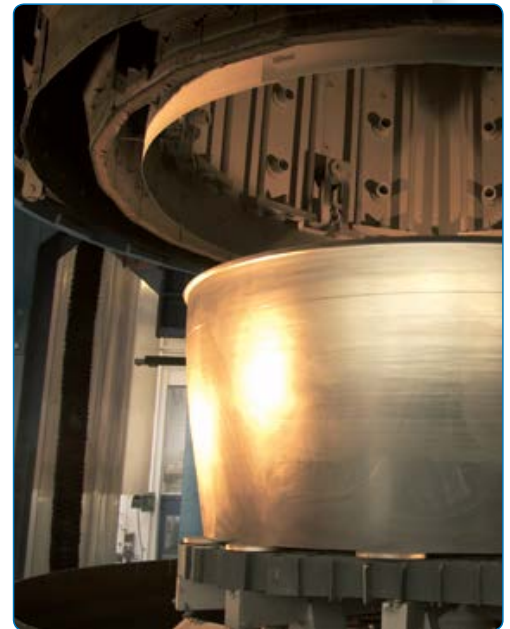
b.kuntzmann@listemann.com

www.listemann.com



LORD

AskUsHow™

LORD is an international corporation operating in the Aerospace&Defense, Automotive, Energy and Industrial sectors. In Aerospace and Defense, it specializes in flight-critical motion control and dynamic subsystems. Representative product lines include elastomeric bearings and lead-lag dampers for helicopter rotorheads, engine attachment systems for fixed- and rotary-wing aircraft, passive and active vibration control systems and in-flight propeller balancing systems. LORD provides a full service from the requirement specification to a fully qualified and certificated product.

LORD provides optimized solutions to its customers thanks to a strong focus on innovation. Recent innovations include omnidirectional active vibration control as well as ultraconductive coatings for lightning strike protection and EMI shielding.

Learn more about LORD at www.lord.com



LORD CORPORATION

Chemin du Pavillon 2
CH-1218 Le Grand-Saconnex
T +41 22 761 50 68
M +41 79 368 76 96
info@lord.com
www.lord.com



MAGENTA**SY**S

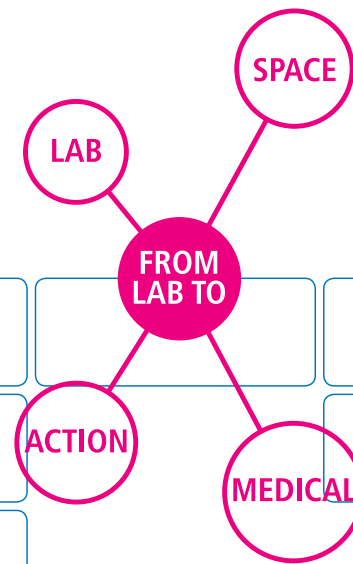

MagentaSys is a small company based in Geneva and proposing:

- modular electronic
- integrations services
- Software and firmware development

Created in 2005, MagentaSys is proposing top-of-the-art technology to our innovative customers including research labs (CERN, PSI, ETH, GSI), medical industry and defense.

With a strong background in:

- GHz acquisition/ generation systems
- FPGA based signal processing
- fast recorder-players

Since our beginning, we have been building solutions for various defense applications when high performance electronic is a key to success: SIGINT, COMINT, Simulators and Testers.

Time-of-flight measurement, Data reduction, FFT, throughput, DDC, FIR, ADC, DAC, HPC, LASER, RADAR and SONAR are keywords for us. We integrate and propose most of the popular industrial format in use today: VPX, aTCA, uTCA, AXIe, PXIe, PCIe, from the server in data-center to the GS/ airborne rugged recorder with COTS components.

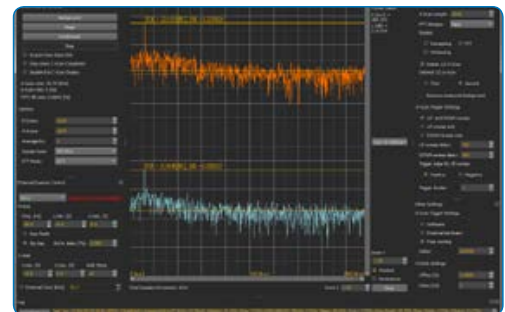
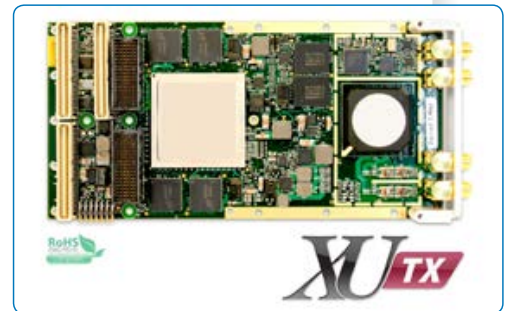

MagentaSys

5 rue des Sablières
ZI Meyrin - Satigny
CH-1242 Satigny
+ 41 22 366 33 33
info@magentasys.ch
info@magentasys.com



A company of
glatrösch

MECAPLEX 
SWITZERLAND

The transparencies and aerostructure company MECAPLEX, founded in 1948, employs 45 specialists for the aeronautical industry and belongs to the Glas Trösch Group since 2011. The manufacturing program reaches from the windshield of a Very Light Aircraft or a small Light Lens up to the stable 30 mm thick windshield of a Fighter Aircraft.

Optical quality and order processing are certified to aerospace standards.

ACTIVITIES Development and definition of canopies and complete systems; Manufacture of certified transparencies; Production of aircraft structural assemblies; Repair / replacement and overhaul of windshield- and cabin-assemblies **MAIN PRODUCTS** Canopies; Taxi Light Lenses; Windshields; Wing Tip Lenses; Automotive Glazing; Yacht Cabin Windows; Sub- and Main Assemblies; Aerostructures; Complete Canopy – Assemblies; Designer Parts **MATERIALS** Cast or stretched acrylic glass; Polycarbonate; Plastic or metallic frames **SPECIALTIES** Heated – windshields for anti-fog or de-icing; Transparencies with hard coatings; Laminated hybrid glasses (i.e. glass/acrylic, polycarbonate/acrylic) **CERTIFICATIONS** EN 9100:2009; EASA Part 21, Section A, Subpart G; other aeronautic companies

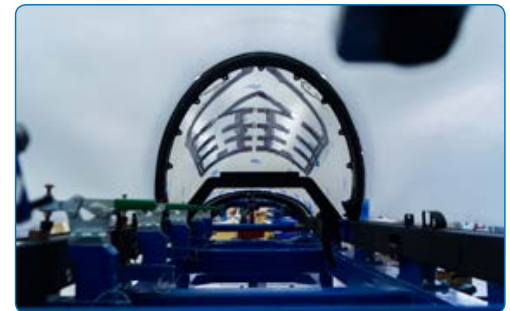
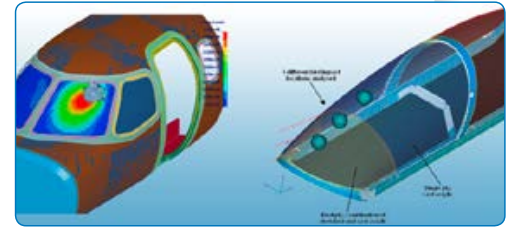

Mecaplex AG
Solothurnstrasse 138
CH-2540 Grenchen
+41 32 644 22 11
info@mecaplex.ch
www.mecaplex.ch

MEGGITT

smart engineering for
extreme environments

To cut the cost of unscheduled and unnecessary maintenance, system operators must anticipate wear and tear and recognise incipient failure conditions. They come to Meggitt in Switzerland for the latest sensing and condition-monitoring tools. Our engine monitoring units integrate diagnostic and prognostic systems that turn data into explicit maintenance actions and monitoring into active management of system condition.

Meggitt has been at the vanguard of vibration monitoring for over 50 years. Today, our sensors monitor virtually every parameter—acceleration, pressure, force, temperature, distance, position and vibration—and perform in almost unimaginable extremes of heat and vibration.

We create the raw material at the heart of our sensors. We design the brains of our systems—the software algorithms and the process electronics. We make the cables, connectors and networking tools that constitute the nervous system of our data acquisition products.

It's this combination that makes us one of the industry's most attractive partners, delivering everything from simple signal conditioners to complex engine health monitoring systems.



Meggitt Sensing Systems

Rte de Moncor 4, PO Box 1616
CH-1701 Fribourg
+41 26 407 1111
info@ch.meggitt.com
www.meggitt.com





Mercury Mission Systems, International S.A. (MMSI), previously CES Creative Electronic Systems, is a Swiss legal entity and part of Mercury Systems Incorporated which headquartered in Andover, Massachusetts, USA. MMSI is Mercury's Center-of-Excellence for Design Assurance Level (DAL) flight safety-certifiable processing product development and manufacturing.

Mercury's expertise and experience has been acquired over three decades. This domain knowledge is built in to our rugged, flight safety-certifiable processing, avionic I/O, video and avionics Ethernet solutions. Our third generation safety-certifiable (DO-178/254) subsystem building blocks have backwards compatibility and are designed with a top-down approach for interoperability and ease of subsystem pre-integration.

Mercury's safety-certifiable solutions may be modified (MOTS) or straight off the shelf (COTS). Both are supported by our teams of experienced professional engineers who number over half MMSI's staff. Mercury's solutions are ideally suited to C4ISR, radar and EW applications requiring the highest DAL (DAL-A) certification. Our mission computing solutions are trusted in commercial and military, manned and unmanned platforms around the world.



Mercury Mission Systems International

Av. Eugène-Lance 38
PO Box 584
CH-1212 Grand-Lancy 1
+41 22 884 51 00
www.mrcy.com



meteolabor[®]
Reliable Measurement and Protection

Meteolabor AG is a leading swiss engineering company in two areas: Meteorological precision instruments and Lightning / NEMP protection.

Our success in meteorological instruments is based on two product lines. Our upper air sounding systems and the sensors for automatic weather stations. **Thygan** is one example of such a sensor, it contains both a ventilated, heated thermometer as well as a high precision dew point mirror. The instrument is built to withstand extreme outdoor conditions and fulfills the highest requirements in reliability, precision, and sensitivity. **Fog detection included.**

In lightning and HEMP/NEMP protection, we produce high-class filters for the protection of personnel and electrical systems. A properly mounted filter can be used to protect objects like datacenters, power plants, aircrafts and vehicles, ships, radars and military command centers. These filters are MIL-STD-188-125 compliant, but not only that. MIL STD-188-125 is mainly for HEMP/NEMP, however our devices do both: HEMP/NEMP and lightning protection.



Meteolabor AG

Hofwiesenstrasse 92
CH-8620 Wetzikon
+41 44 934 40 40
info@meteolabor.ch
www.meteolabor.ch





NOBAG Nobs Engineering AG was developed from its parent company, Nobs Maschinenfabrik AG, which was established in 1919. For decades, the name Nobs® has been associated around the world with excellence in

- Slitting Lines
- Cold Flow Presses and
- Special Purpose Machines.

Our customer's – yours – advantage is our focus. We develop individual, unique systems, tailored to your requirements by using state-of-the-art CAD tools. We take overall responsibility to turn your visions into reality. We apply our expertise, our decades of experience, sound of knowledge and our innovative ideas to development. We even guarantee service and the availability of spare parts for decades to come. NOBAG's Cold Flow Presses manifest more than 80 years of experience, resulting in reliable, long lasting machines, producing with highest quality and accuracy.

Our comprehensive ability in manufacturing a wide range of various Cold Flow Presses for pistol-, infantry- and middle caliber cartridges will meet your highest expectations. As a customer once said: NOBAG's experience hit the bull's eye and our wishes on solutions!

NOBAG – your solution.

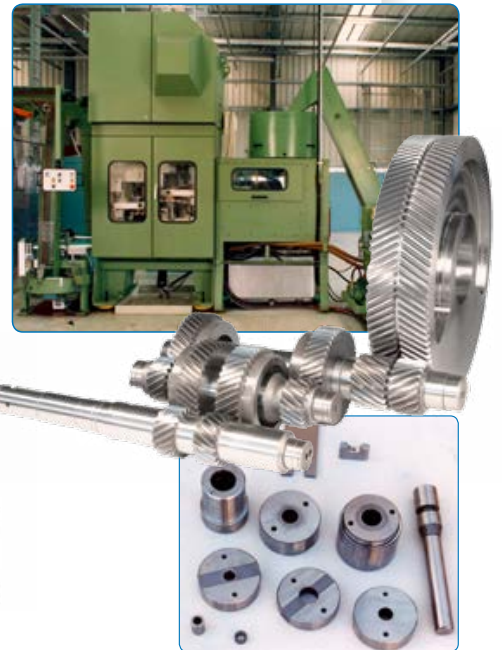

NOBAG Nobs Engineering AG

Glütschbachstrasse 61

CH-3661 Uetendorf

+41 33 334 56 56

info@nobag.com



oerlikon metco

Oerlikon Metco provides functional coatings that play a vital role in maximizing aviation operational efficiency and safety. Aviation customers benefit from a uniquely broad range of surface technologies, coating solutions, application equipment, materials, services and manufactured aviation components.

Improved jet engines Our coatings manage tight gas-path clearances between rotors and stators, reduce thermal effects and control wear and corrosion within the engine. Capabilities also include the manufacture of critical engine components such as seal segments, sealing rings and vane assemblies.

Improved airframe components Our hard face coatings deliver durable resistance against fretting, sliding and general surface wear and corrosion to airframe components such as actuators, flap tracks and landing gear.

Capabilities With our broad range of products and services and our global presence, Oerlikon Metco provides industry solutions for aviation, power generation, automotive, oil & gas and other specialized markets. Hence, we enable customers to extend component life cycles, reduce downtime and increase productivity.

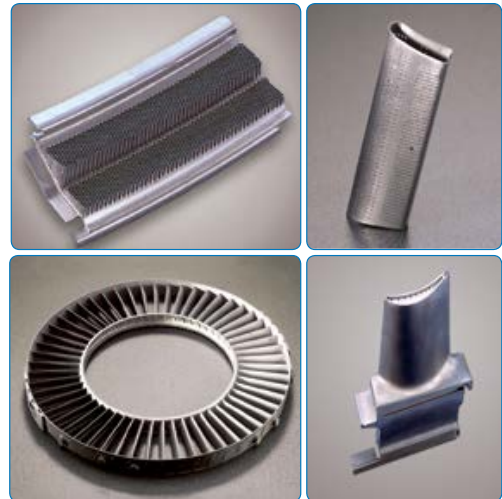

Oerlikon Metco AG, Wohlen

Rigackerstrasse 16

CH-5610 Wohlen

Tel. + 41 56 618 81 81

Fax + 41 56 618 81 00

www.oerlikon.com/metco





INVESTMENT CASTING
World class foundry



With 45 years experience Precicast is one of the largest investment casting foundries in Europe. It is recognised to be among the technology world leaders and specialised in nickel- and cobalt-based super alloy as well as in stainless steel investment castings for jet engines, land-based gas turbines and medical implants. We manufacture high complex structural castings (up to 1 meter in diameter or 250 Kg of pouring weight) and solid and hollow airfoils (equiax, directionally solidification and single crystal).

The Precicast engineering team is committed to support its customers from the early stage of design of new components in order to optimize their total cost and technical targets. We guarantee our customers on-time deliveries and a high quality level of our products.

Precicast holds the following quality certification: ISO 9001:2008 - EN 9100:2009 - ISO 14001:2004, Nadcap NDT, WELDING, HEAT TREATING

Precicast is certified supplier for the major OEM and their partners, like for example: Safran – General Electric – Rolls Royce – Siemens. Precicast has been operating for more than 15 years in the ESA space program, providing engine components for ARIANE 5 and VINCI.



PRECICAST SA

Via Resiga 6
CH-6883 Novazzano
+ 41 91 695 77 11
sales@precicast.com
www.precicast.com



QUANT™

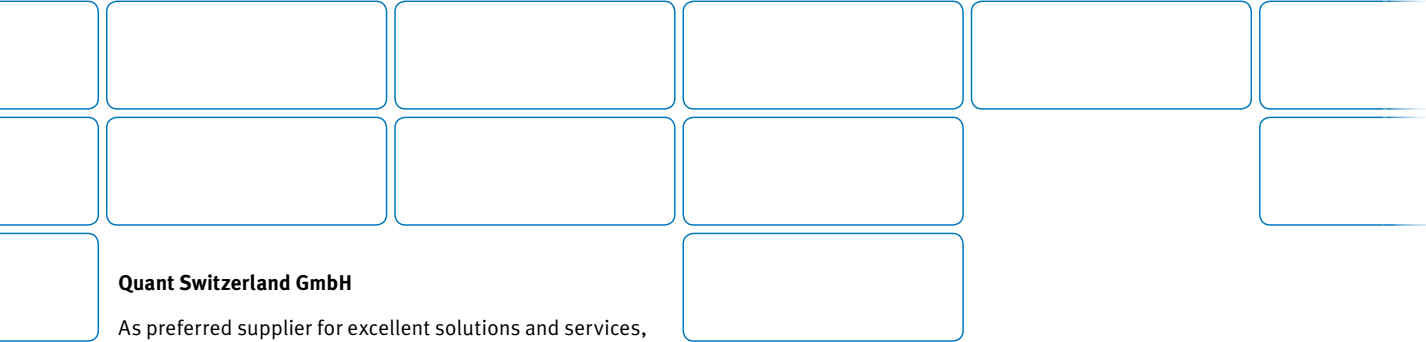

Quant Switzerland GmbH

As preferred supplier for excellent solutions and services, we are fast and professional in project execution and helping our customers to be successful on the market.

Manufacturing Service – reliable, fast, customer-oriented

The Manufacturing Service team will simplify your daily work. Our specialists provide reliable, fast and comprehensive services in the areas of sheet metal working, machining, heat treatment and assembly. We have our strengths in the area of engineering, designing, purchasing (including EM supply) and manufacturing of prototypes, assembly groups and production of small and middle series for high stressed applications. We are also able to take the responsibility for the entire supply chain and logistics starting with the choice of the optimal packing, international transport and shipping and complete product support during the whole life cycle.

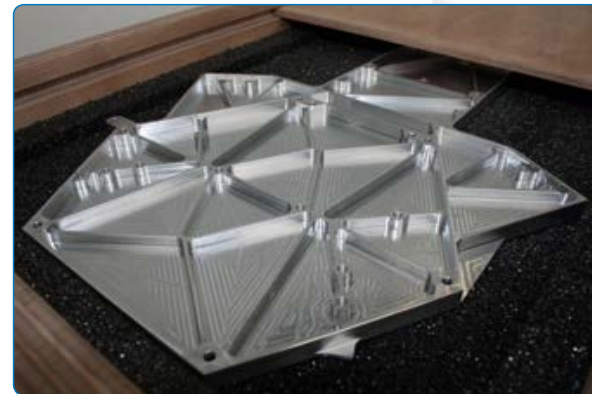

Quant
Switzerland GmbH
Manufacturing Service
Industriestrasse 34
CH-5314 Kleindöttingen
+ 41 58 586 50 12
www.quantservice.com





Rheinmetall Air Defence AG, formerly known as Oerlikon Contraves AG, is one of the world's leading manufacturers of state-of-the-art anti-aircraft systems. In the domain of cannon-based air defence technology, the company is the global leader and the sole single-source supplier of fire control systems, automatic cannon, integrated missile launchers and Ahead ammunition.

The core competency of this internationally operating company is the development and manufacture of advanced air defence systems as well as simulators and training systems.

Around the globe, the armed forces of more than 40 nations have come to rely on the multifaceted, automated and highly effective air defence solutions produced by Rheinmetall Air Defence. Among the company's best-known products are its widely introduced Skyguard twin gun system and the Skyshield generation with its pioneering revolver guns.

Rheinmetall Air Defence advises and assists customers on introducing new and existing weapon systems and on meeting their logistical and maintenance needs. Moreover, it provides the necessary training and combat upgrade packages for life cycle extensions of weapon systems.



Rheinmetall Air Defence AG

Birchstrasse 155

CH-8050 Zürich

+ 41 44 316 22 11

info@rheinmetall.com

www.rheinmetall-defence.com





Rheinmetall Swiss SIMTEC AG, a wholly owned subsidiary of Rheinmetall Defence Electronics GmbH, was founded in 2009. The company is located in Thun.

The core competencies of this internationally operating company are the development and manufacture of prototypes and series production systems for simulation and training, including the associated hardware and software. The company advises and assists customers from both the military and civilian sector.

Currently the company is developing a simulation system for emergency drives with blue light. Since 2013 speed merchants legally get punished more severely in Switzerland. The stricter punishments also apply to the police, emergency and fire services. Therefore the need for the training of emergency drives with blue light has increased immensely.

The company's main goal is always to find innovative solutions for the challenges their customers face. In this, Rheinmetall Swiss SIMTEC AG benefits from their employee's long-term knowledge and know-how as well as the parent company's experience. To ensure trusting and sustainable relationships quality management is particularly important to Rheinmetall Swiss SIMTEC AG.



Rheinmetall Swiss SIMTEC AG

Frutigenstrasse 4

CH-3600 Thun

+ 41 33 533 02 00

info@swiss-simtec.ch

www.swiss-simtec.ch



Rheinmetall Technical Publications supplies civil and military customers with sophisticated integrated logistics engineering and technical publications support services. The portfolio includes the production of technical publications for operating, inspecting, repair and maintenance, as well as spares documentation for air, land and naval systems. Logistics analysis and concepts are also produced as part of logistics engineering.

Technical documentation is a prerequisite for the certification and operation of military and civil aircraft and systems. Adhering to the latest standards and processes, Rheinmetall Technical Publications offers its customers technical publications tailored to their specific requirements. For conventional documentation and Interactive Electronic Technical Publications (IETP) alike, the company operates in accordance with all the applicable standards, processes and requirements. The company holds all the necessary aeronautical and quality management certifications needed for this purpose.

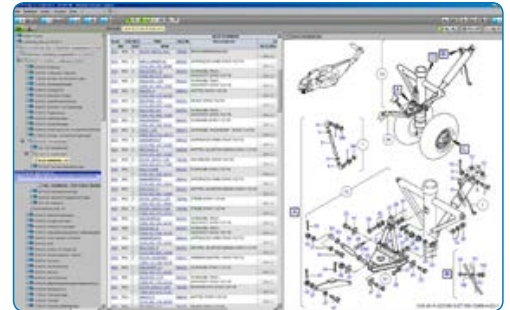

Rheinmetall Technical Publications Schweiz AG

Birchstrasse 155
CH-8050 Zürich
+ 41 44 316 22 11
rtp-ch@rheinmetall.com
www.rheinmetall-tp.com



For nearly 70 years, Roschi Rohde & Schwarz AG has been one of the leading trading and engineering companies for communications technology, test and measurement and non-proprietary maintenance in Switzerland. Roschi Rohde & Schwarz AG extends the Rohde & Schwarz portfolio with over 10 additional suppliers to answer Swiss customers needs.

Core Competences – From Single Unit to the Turnkey System

In close cooperation with customers Roschi Rohde & Schwarz AG develops complete and tailored solutions with an overall system warranty. We focus strongly on realizing the customer needs and on maintaining a long-term, open and successful customer relationship. This ensures the full involvement of all participants and allows a very efficient, streamlined, transparent and successful project management as well as a sustainable system support throughout the solution life cycle.

Business Fields

- Test and Measurement
- Broadcast and media
- Radiocommunications systems
- Radiomonitoring and radiolocation
- Information and communications security
- Software and ICT services
- General contractor / system integrator
- Manufacturer-independent maintenance

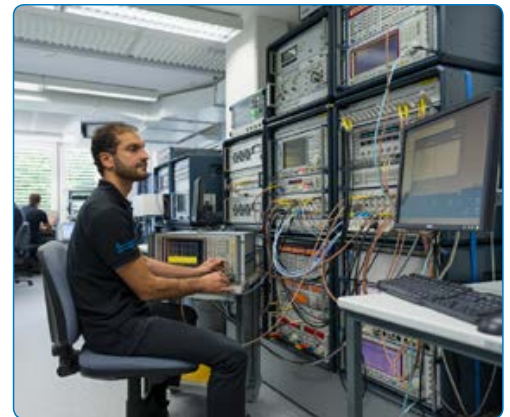
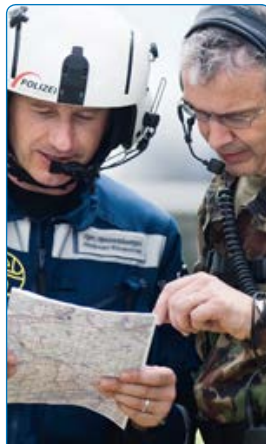

Roschi Rohde & Schwarz AG

Mühlestrasse 7

CH-3063 Ittigen

+41 31 922 15 22

sales@roschi.rohde-schwarz.com

www.roschi.rohde-schwarz.ch



Together ahead. RUAG

The RUAG Group brings advanced technologies, unfailing delivery and mission critical reliability to industrial partners, governments, law enforcement organizations and armed forces – on land, in the air and in space.

On land RUAG is a leading independent provider of integration, upgrade and maintenance services for land-based defence and security systems covering; Heavy Weapon Systems, Simulation & Training, C4I/STAR Systems and Cyber Security. Its in-house product portfolio comprises one-of-a-kind subsystems and components for national and international customers. Furthermore, RUAG is a market leader in small-calibre ammunition, pyrotechnic elements and components for the hunting & sports.

In the air RUAG is the center of excellence for civil and military aircraft maintenance and for developing, manufacturing and integrating aviation systems and subsystems. Moreover, RUAG specializes in the development, manufacturing and final assembly of fuselage sections for passenger aircraft, wing and control surface components.

In space RUAG is the leading supplier of products for the space industry in Europe. Experience, outstanding reliability, customer focus and a comprehensive, clearly structured product portfolio all make RUAG Space the partner of choice for manufacturers of satellites and launchers across the globe.

We listen to make it right.
We stay to make it real.
A promise you can trust.



RUAG Holding AG
Stauffacherstrasse 65
CH-3000 Bern 22
+41 31 376 64 50
info@ruag.com
www.ruag.com



Saab Bofors Dynamics Switzerland Ltd.explosive innovation **Saab Bofors Dynamics Switzerland Ltd – Leading Explosive Innovation**

More than 150 years of experience have been accumulated in today's solutions. This long history has allowed the development and acquisition of specific skills for the design and manufacture of high-performance explosive energetic solutions, offering:

- Advanced simulation and modelling capabilities; to reduce time from design to deployment
- Isostatic pressing process on industrial level; for producing very high-performance explosive charges
- Mastering warhead technologies; permits the design and manufacture of high-efficient solutions with optimum integration
- Competent experienced engineering team in armour penetration and behind armour effects; to fulfil all customer requirements
- Accurate manufacturing resources; to ensure the highest and sustainable product quality

From our long history and experience unique competencies are available to offer our partners and customers additional exceptional value to their existing and new products and design solutions.

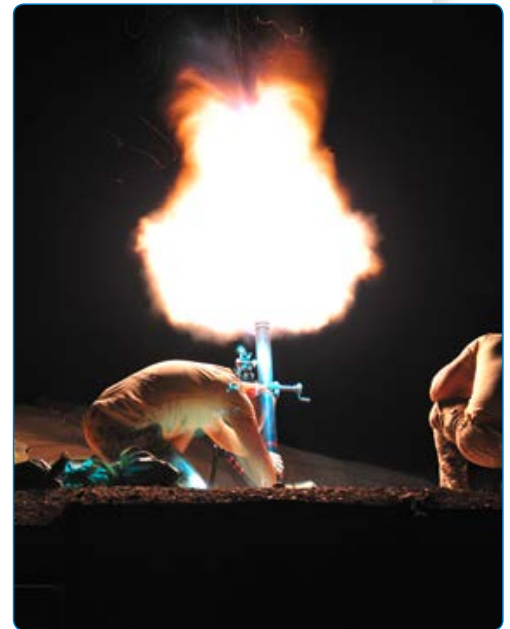

**SAAB Bofors Dynamics
Switzerland Ltd.**

Allmendstrasse 74
CH-3600 Thun

+41 33 227 74 74
sbds@saabgroup.com
www.saabgroup.com



Sub-assemblies & machining of technical structural parts

Most of the key players of the aerospace market plan a strong growth, asking for lightweight materials with high mechanical properties. Saint Jean Aero develops its competencies in this way to offer mechanical parts with complex shape and a high accuracy.

From the co-engineering to the serial production, Saint Jean Aero is able to manage the complete international supply chain including raw material procurement, internal and external operations, and customer's deliveries worldwide.

→ **Titanium, Inconel and other hard metal for the military and commercial aerospace industry**

Typical part samples: Roller Track , Empennage casing, Attachment Track, Hinge, Ribs....

2016 BOEING Gold Supplier

2015 BOEING Gold Supplier

2014 BOEING Gold Supplier



Saint Jean Aero

Chemin du champ-des-filles 7

CH-1228 Plan-les-Ouates

+41 22 884 19 50

www.stjaero.com



Sauter Bachmann

Experienced, visionary, internationally focused.

In the mountainous valley of the Canton of Glarus it takes one thing in particular to build a broad horizon: visionary thinking! It's this pioneering spirit which has always been a tradition in the Canton of Glarus and to which Sauter Bachmann aspires.

This attribute has driven Sauter Bachmann since its foundation in 1922 to building its international reputation. Top quality gears and gearboxes built to your highest expectations made by Sauter Bachmann Precision Gears.

Actuation systems, such as the Pilatus PC-12 "Landing Flap Actuation System", have been one of the door openers for Sauter Bachmann into the aerospace market.

Design optimisation, product development, manufacturing and assembly, testing under environmental conditions. All made in-house by Sauter Bachmann – your partner for low and high speed gearing applications!



Sauter, Bachmann AG

Zaunweg 10

CH-8754 Netstal

+41 55 645 40 11

info@sauterbachmann.ch

www.sauterbachmann.ch



starrag

Starrag Group

Starrag Group is a global technology leader in manufacturing high-precision machine tools for milling, turning, boring and grinding of small, medium-sized and larger workpieces of metallic and composite materials.

Our customers are primarily internationally active companies in the Aerospace, Transport, Industrial and Energy sectors. In addition to its portfolio of machine tools, Starrag Group provides integrated technology and maintenance services that significantly enhance customer productivity.

Starrag Group products are marketed under the following strategic brands: Berthiez, Bumotec, Dörries, Droop+Rein, Heckert, Scharmann, SIP, Starrag, TTL, WMW.

Headquartered in Rorschach/Switzerland, the Starrag Group operates manufacturing plants in Switzerland, Germany, France, the UK and India and has established a network of sales and services subsidiaries in numerous other countries.

Starrag Group is listed on the SIX Swiss Exchange (STGN).



Starrag AG

Seebleichstrasse 61

CH-9404 Rorschacherberg

+41 71 858 81 11

info@starrag.com

www.starrag.com



SUHNER

The SUHNER Group of Companies is a leading global provider of transmission components and machining equipment for original equipment manufacturers, aerospace manufacturers as well as maintenance, repair and overhaul companies.

Our diversification, coupled with customer value through cost-effective solution offerings, allow us to respond to the changing needs of our customers and the marketplace. More than 700 employees in the Suhner Group of Companies worldwide commit themselves every day to the high quality of our solutions for the benefit of our customers. All products are designed, manufactured, tested and qualified in-house.

Machine Equipment for drilling, milling, tapping and surface treatment of Aluminum, Titanium and CFRP/Al/Ti multilayer stacks optimized for efficient manufacturing of aerospace components. Our products are designed to be operated either manually, CNC controlled or in a dedicated robot solution as per your requirement.

Aerospace grade high-torque **Flexible Shafts** designed for application where there is little or no accurate alignment between the power source and the driven part or allows no power source to be located at the driven part.

Our **Spiral Bevel Gears** offer highest pitch and spacing quality while overachieving reliability requirements. Our gears are the perfect fit for auxiliary drive gears for various applications as well as main drive gears for engine driven accessories.

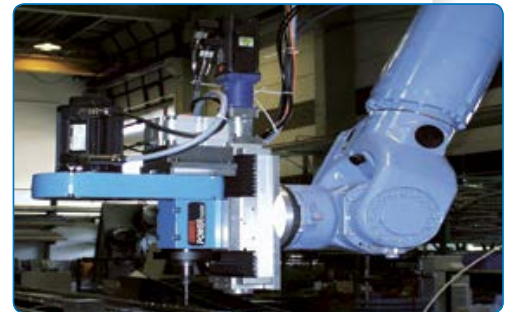

OTTO SUHNER AG

Industriestrasse 10

CH-5201 Brugg

+41 56 464 28 28

aerospace@suhner.com

aerospace.suhner.com



Swiss Prime Protection SSZ Camouflage Technology AG is a Swiss high performance company in signature management and the global technology leader in the field of multispectral camouflage.

Our camouflage products are designed to counter surveillance by all modern sensor types operating in all relevant spectral ranges (visual, near as well as thermal infrared and Radar). Our product range covers static and mobile vehicle and object camouflage as well as personal camouflage.

Mobile object camouflage means the fix attachment of camouflage on vehicles.

Static camouflage means the conventional use of the camouflage net. An immovable object will be assimilated to the background by using a camouflage net (2- or 3-dimensional).

With our know-how we developed a special suit (similar to a ghillie suit) that prevents soldiers from being detected by a thermal imaging camera. Its camouflage effectiveness is based on a low emissivity surface.

For more information, visit our homepage.

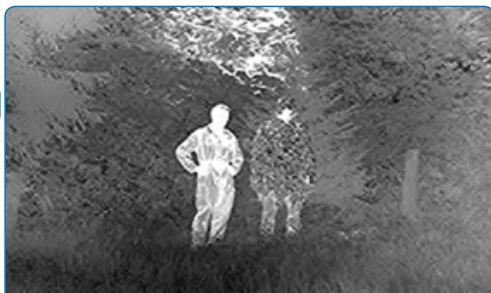

SSZ Camouflage Technology AG

Grienbachstrasse 11

CH-6300 Zug

+41 41 768 01 40

info@ssz-camouflage.ch

www.ssz-camouflage.ch

SWISS
ARMS

SIG SAUER®

The unfailing Reliability and Accuracy.



The company SAN SWISS ARMS AG, successor of the SIG ARMS AG, is the oldest arms manufacturer in Switzerland. More than 150 years of precision arms manufacturing constitute a solid foundation of experience. Since 2000, this independent company is a member of the L&O Group, a leader also in the weapons industry.

The grown over centuries expertise, the innovative technologies and the traditional awareness of quality combined with a competent, powerful team in construction, production and maintenance have become today a unique alliance.

Elaborate technology and design of our products lead to outstanding results and global acceptance of both the professional and the civil sector alike. Large-scale tests in the alpine regions of Switzerland prove the unrivalled reliability of our products even if influenced by dust, sand, mud and extreme cold. They exceed multiply the STANAG criteria.

As the main system supplier of the demanding Swiss Army we continuously optimize the range of materials, design and manufacturing along with the practical experience. The proverbial „Swiss Precision“ accuracy and the absolute reliability under harshest conditions are the proud result of this constant development.



SG 751 · 7.62x51 NATO



SG 553 · 5.56x45 NATO



SG 553 · .300 BLK



SG 553 R · 7.62x39



GLG & GL Grenade Launcher · 40 mm

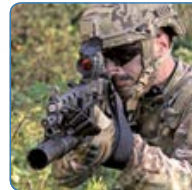

SAN SWISS ARMS AG

Industrieplatz 1

P.O. Box 1071

8212 Neuhausen / Rheinfall

Tel. +41 52 674 65 65

Fax +41 52 674 64 18

www.swissarms.ch



Systems Assembling SA

Outsource Manufacturer

Leading Outsource Manufacturer of Electrotechnology

Systems Assembling SA, with his headquarters in Boudry, Switzerland, is one of the leading outsourcing manufacturers of Electro technology for the aeronautic, defence and security sector. Founded in 1997, Systems Assembling SA has more than fifteen years experience in cable confection, construction and assembling of harnesses, electrical devises and drawing of electrical schemata.

The company Outsource manufacturer in electro technology for the medical market, industry, aeronautic, security and defence sector.

Quality Norms and Standards Systems Assembling's Quality Systems respect the following standards: ISO-9001, EM, UL, CE, MIL, IPC 610, IPC 620

Quality Management System Systems Assembling's Quality Management System is adapted to changes in technology and production processes. Our change processes are always focused on the customers benefit.

Key data Staff streght: 100

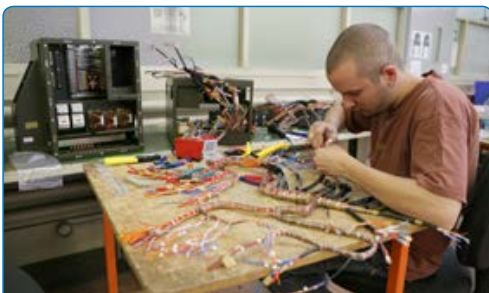

Systems Assembling SA

Chemin des Conrardes 12
CH-2017 Boudry
+41 32 843 47 47
assembling@sya.ch
www.sya.ch



THALES

Thales Suisse SA is an affiliated company of the international Thales Group and employs 305 qualified professionals. With our hand-picked team of highly skilled engineers, we are committed to excellent performance. As the group's center of competence for line-of-sight Radio systems, we develop cutting edge technology for Switzerland and for the world market. Our mission control- and power management systems optimize the reliable, user-friendly operation of military vehicles.

We are renowned for the integration of tactical systems for C4I STAR, Simulation and Air Defence. The C2I System for the Land Forces, the full flight Helicopter Simulators (level D certified) and the NBC (Nuclear, Biological, Chemical) Recce vehicles are only a few examples of well-known projects in which we have proven our expertise. Thanks to the exceptional collaboration with our customers, we have acquired an outstanding reputation as

- prime contractor
- product supplier
- system integrator
- service & solutions provider

Thales Suisse SA prides itself on its commitment to understanding and serving the needs of its clients and on delivering, in terms of quality, time and cost.



Mobile communication node

- Line of sight Radio new generation
- 100 Mbits/sec with 40 km range
- Self-adapting data rate
- IP ready and SNMP remote control



Thales Suisse SA

Binzstrasse 18
CH-8045 Zurich
+41 44 457 17 17
info@ch.thalesgroup.com
www.thalesgroup.ch





“Securing an uncertain world” Safran Vectronix is an established leader in the development and manufacture of integrated handheld, mounted, modules and precision systems for observation, detection, geo-positioning, and targeting solutions. Leveraging core competencies in electro-optics, laser range finding, and northfinding technologies, Safran Vectronix supports the requirements of defense and law enforcement as well as industrial and commercial markets. Headquartered in Heerbrugg Switzerland, Safran Vectronix AG is owned by Safran Electronics & Defence (Safran group) and maintains two subsidiaries with four branches in the US.

Guided by the principle “Quality and Precision meets the most exacting demands” it has been our aim as an innovation leader for more than 90 years, to provide state-of-the-art solutions for observation and geo-location under harsh field conditions.

Our products are characterized by high reliability as well as enduring quality according to the most stringent standards. With the use of state-of-the-art technology, Safran Vectronix products master difficult circumstances with a simple and easy user interface.

Safran Vectronix – The Swiss brand for the highest standards.



Safran Vectronix AG

Max-Schmidheiny-Strasse 202

CH-9435 Heerbrugg

+ 41 71 726 72 00

www.safran-vectronix.ch

ViaSat

ViaSat Antenna Systems, S.A., based in Lausanne, Switzerland is an affiliated company of the international ViaSat group. ViaSat is a global leader in the field of satellite communications.

Our over 3'000 employees ViaSat connects people to new communication applications with networking systems and services that enable a fast, cost-efficient, secure, and high-performance connection to virtually any location. The Company offers Exede® high-speed internet and broadband services, worldwide mobile satellite services, including **high-speed in-flight internet for Commercial and Business Jet Aviation**; network-centric military communication systems...

ViaSat in Lausanne is **focused on:**

- Design of **smart user terminals for High broadband communications** for all types of Mobile platforms: Air, Sea and Land.
- **Advanced Data Delivery & Analytics Services** that are ensured by flying operations of all types of Aircrafts: Manned and Unmanned (UAVs).
- ViaSat in Lausanne has become a key player on Drones projects and is contributing to most of European project with most of stakeholders of the UAV industry. One of the most advanced offering is consisting in providing Key components of **UTM (UAV Traffic Management) services that are enabling UAV to fly BVLOS (Beyond Visual Line of Site)** in civilian airspace.

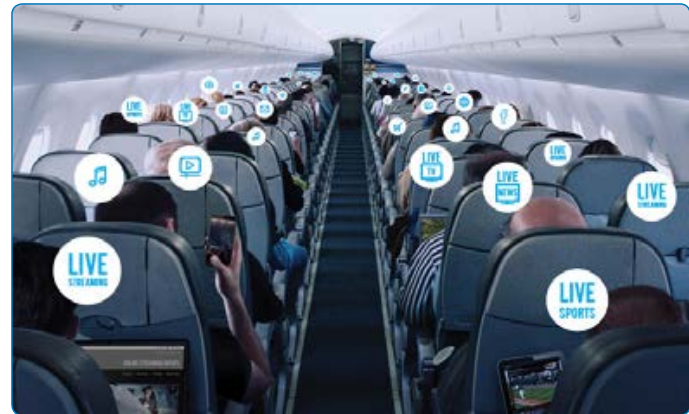

ViaSat Lausanne
EPFL Innovation
Park Bâtiment
CH-1015 Lausanne
+ 41.21.691.4062
www.viasat.com



Feel the Drive

Heating and Air-Conditioning Systems for Defense Vehicles and Mobile Shelters

For more than 75 years, the Webasto group set new technological standards – in both the original equipment sector and the aftermarket. As one of the 100 biggest suppliers in the automotive industry worldwide, Webasto develops and produces roof, convertible as well as heating, cooling and ventilation systems.

Dedicated to defense market requirements Webasto offers air-conditioning and heating systems which allow the crew to be mission-ready and also help save costs. As a result, even with the engine off, hydraulic fluids and equipment can be kept at an optimum temperature, even with outside temperatures at -46°C .

Webasto takes cooling to the next level with its new reliable and robust range of mobile shelter cooling products. Our units provide outstanding performance and high quality. A full line of split and compact air-conditioning systems are available. Solutions can also be engineered to fit customer needs.



Webasto Thermo & Comfort Schweiz AG

Hagmattstrasse 4
CH-4123 Allschwil
Tel. +41 61 486 95 80
markus.ming@webasto.com
www.webasto.ch



Swissmem

Pfingstweidstrasse 102

CH-8037 Zürich

Telephone +41 44 384 41 11

Telefax +41 44 384 42 42

www.swissmem.ch

www.swiss-asd.ch

info@swissmem.ch



SWISS ASD
Aeronautics, Security
& Defence